

# USER'S GUIDE

## TABLE OF CONTENTS

**Welcome** ..... 1  
**Safety Instructions** ..... 2-3  
**Installation Recommendations** ..... 4  
**Control Panel** ..... 5-6  
**Oven Features at a Glance** ..... 7  
**Operating Basics** ..... 8-11  
**Special Features** ..... 12-17  
**Care and Cleaning** ..... 18-20  
**Questions and Answers** ..... 21  
**Before You Call** ..... 22  
**Warranty** ..... 23  
**Four à Micro-ondes Mode d'Emploi** ..... 24  
**Horno de Microondas Guía del Usuario** ..... 48

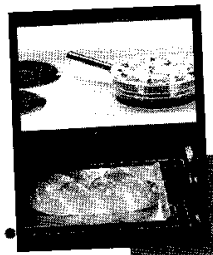
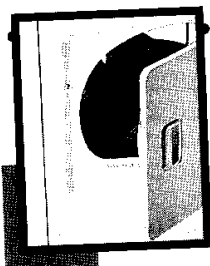
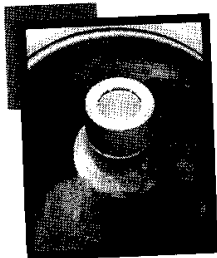

KEEP THESE INSTRUCTIONS FOR FUTURE REFERENCE



**Model: MMV5000B**

## Welcome.....



Welcome and congratulations on your purchase of a Maytag Microwave Oven! Your complete satisfaction is very important to us.

**Read this manual for best results.** It contains instructions to acquaint you with proper operating and maintenance procedures.

**Save time and money.** If something should go wrong, we suggest consulting the "Before You Call" section in the back of this book. It is designed to help you solve basic problems before consulting a servicer.



However, should you need assistance, it is helpful to:

1) Have complete model and serial number identification of your microwave. This is located on a data plate on the left inside wall of the oven when the door is open. Record these numbers below for easy access.

### Model Number

-----

### Serial Number

-----

2) Have proof of original date of purchase. Please save your sales receipt.

For additional questions, please contact us:

Maytag Appliances Sales Company  
Attn: CAIR® Center  
P.O. Box 2370  
Cleveland, TN 37320-2370  
1-800-688-9900 (USA)  
1-800-688-2002 (CANADA)  
1-800-688-2080 (U.S. TTY for deaf, hearing impaired or speech impaired)  
(Mon.-Fri., 8am-8pm Eastern Time)  
Internet: <http://www.maytag.com>

For service and warranty information, see page 23.

*NOTE: In our continuing effort to improve the quality of our appliances, it may be necessary to make changes to the appliance without revising this guide.*

## PRECAUTIONS TO AVOID POSSIBLE EXPOSURE TO EXCESSIVE MICROWAVE ENERGY

- A. **Do not** attempt to operate this oven with the door open since open-door operation can result in harmful exposure to microwave energy. It is important not to defeat or tamper with the safety interlocks.
- B. **Do not** place any object between the oven front face and the door or allow soil or cleaner residue to accumulate on sealing surfaces.
- C. **Do not** operate the oven if it is damaged. It is particularly important that the oven door close properly and that there is no damage to the: (1) door (bent), (2) hinges and latches (broken or loosened), (3) door seals and sealing surfaces.
- D. The oven should not be adjusted or repaired by anyone except properly qualified service personnel.

## Registration

Federal law requires registration of all microwave ovens. To comply with the law, please fill out the PRODUCT REGISTRATION CARD packaged in the oven.

1. Check the model and serial numbers on the card to see that they match the numbers on the data plate. The data plate is located on the left inside wall of the oven opening. If the numbers on the card are not the same as those on the data plate, cross out the numbers on the card and write in the numbers as they appear on the data plate.
2. Mail the card. The return address is included on the reverse side of card.

If you move or are not the original owner of this oven, you must by law renew the registration. Send the renewal registration information to: **Maytag Customer Service, Warranty Administration, P.O. Box 4970, Cleveland, TN 37320-4970.**

Renewal Registration information must provide: a) Your name and address and b) the microwave oven's model and serial numbers.

# IMPORTANT SAFETY INSTRUCTIONS.....

When using electrical appliances, basic safety precautions should be followed, including the following:

**⚠ WARNING — To reduce the risk of burns, electric shock, fire, injury to persons or exposure to excessive microwave energy:**

1. Read all instructions before using the appliance.
2. Read and follow the specific "PRECAUTIONS TO AVOID POSSIBLE EXPOSURE TO EXCESSIVE MICROWAVE ENERGY" found on page 1.
3. This appliance must be grounded. Connect only to properly grounded outlet. See "GROUNDING INSTRUCTIONS" on page 4.
4. Install or locate this appliance in accordance with the provided installation instructions. Do not mount over a sink.
5. **This over-the-range oven was designed for use over ranges no wider than 30 inches.** It may be installed over both gas and electric cooking equipment.
6. **For best operation, plug this appliance into its own electrical outlet, to prevent flickering of lights, blowing of fuse or tripping of circuit breaker.**
7. Some products such as whole eggs and sealed containers – for example, closed glass jars – may explode and should not be heated in this oven. In rare instances, poached eggs have been known to explode. Cover poached eggs and allow a standing time of one minute before cutting into them.
8. Foods with unbroken outer "skin" such as potatoes, sausages, tomatoes, apples, chicken livers and other giblets, and egg yolks (see previous caution) should be pierced to allow steam to escape during cooking. "Boilable" cooking pouches and tightly closed plastic bags should be slit, pierced, or vented.
9. Do not heat, store or use flammable materials in or near the oven. Fumes can create a fire hazard or explosion.
10. Use this appliance only for its intended use as described in this manual. Do not use corrosive chemicals or vapors in this appliance. This type of oven is specifically designed to heat, cook, or defrost food. It is not designed for industrial, laboratory, or commercial use. It is intended for home use only.
11. As with any appliance, close supervision is necessary when used by children.
12. Do not operate this appliance if it has a damaged cord or plug, if it is not working properly, or if it has been damaged or dropped.
13. This appliance should be serviced only by qualified service personnel. Contact nearest authorized service facility for examination, repair or adjustment.
14. Do not cover or block any openings on the appliance.
15. Do not use or store this appliance outdoors. Do not use this product near water – for example, near a kitchen sink, in a wet basement, or near a swimming pool, and the like.
16. Do not immerse cord or plug in water.
17. Keep cord away from heated surfaces.
18. Do not let cord hang over edge of table or counter.
19. When cleaning surfaces of door and oven that come together on closing the door, use only mild, non-abrasive soaps or detergents applied with a sponge or soft cloth.
20. To reduce the risk of fire in the oven cavity:
  - a. Do not overcook food. Carefully attend appliance if paper, plastic, or other combustible materials are placed inside the oven to facilitate cooking. Avoid using recycled paper products. Do not use newspaper or other printed paper in the oven. Such products sometimes contain impurities which could ignite.
  - b. Remove wire twist-ties from paper or plastic bags before placing in oven.
  - c. If materials inside the oven should ignite, keep oven door closed, turn oven off, and disconnect the power cord, or shut off the power at the fuse or circuit breaker panel.
  - d. Do not use the oven for storage. Do not leave paper products, cooking utensils or food in the oven when not in use.
  - e. Do not pop popcorn except in a microwave approved popcorn popper or in a commercial package recommended especially for microwave ovens.
  - f. Do not overcook potatoes. They might dehydrate and catch fire.
  - g. Do not use for drying clothes, linens, newspaper or similar non-food items.
21. Do not operate the oven when empty or with an empty utensil to avoid damage to the oven and danger of fire.

Continued on next page.

# IMPORTANT SAFETY INSTRUCTIONS (cont.) .....

22. Do not lean on the oven door. The door is designed to close tightly and seal properly for safe operation. Leaning on the door may warp or break the hinges.
23. To avoid exposure to dangerous high voltage, **DO NOT REMOVE THE SPLATTER SHIELD** inside the oven cavity.
24. Liquids heated in certain shaped containers (especially cylindrical-shaped containers) may become overheated and splash out with a loud noise. For best results, stir the liquid several times before heating. Always stir liquids several times between reheatings.
25. **Read and follow specific microwave oven preparation instructions on food packages or containers (especially baby food). Above all, this is a cooking appliance designed to prepare food.**
26. Use only cooking utensils and accessories made for use in the microwave and specifically described in this manual.
27. Microwave oven manufacturers do not recommend deep fat frying or frying in a microwave oven. Hot oil can damage oven parts and utensils and even result in skin burns.
28. Plastic wrap: Use only those types designed for microwave oven use and avoid forming an air-tight seal. Fold back a small corner or cut a small slit to allow steam to escape.
29. Stay near the appliance while it is in use and check cooking progress frequently. Leaving the appliance unattended may result in overcooked food and possibly a fire in your oven.
30. **Foods cooked in liquids** (such as pasta) may tend to boil over more rapidly than foods containing less moisture. Should this occur, refer to the Care and Cleaning section for instructions on how to clean the inside of the oven.
31. Do not use a thermometer in food you are microwaving unless the thermometer is designed or recommended for use in the microwave oven.
32. Plastic cookware designed for microwave cooking is very useful, but should be used carefully. Even microwave-safe plastic may not be as tolerant of overcooking conditions as are glass or ceramic materials and may soften or char if subjected to short periods of overcooking. In longer exposures to overcooking, the food and cookware could ignite. For these reasons: 1) Use microwave-safe plastic cookware only and use then in strict compliance with the cookware manufacturer's recommendations. 2) Do not subject empty cookware to microwaving. 3) Do not permit children to use plastic cookware without complete supervision.
33. **So not store anything directly on top of the microwave oven surface when the oven is in operation.**
34. TV dinners may be microwaved in foil trays less than 3/4" deep; remove top foil cover and return tray to box. When using metal in microwave oven, keep metal at least 1 inch away from the sides of the oven.
35. Do not defrost frozen beverages in narrow necked bottles.
36. Cookware may become hot because of heat transferred from the heated food. Potholders may be needed to handle the cookware.
37. Do not try to melt paraffin wax in the oven. Paraffin wax will not melt in a microwave oven because it allows microwaves to pass through it.
38. Never use sharp-edged utensils in or near the oven.
39. Hot foods and steam can cause burns. Be careful when opening containers of hot food, including popcorn bags, cooking pouches, and boxes. To prevent possible injury, direct steam away from hands and face.
40. Clean the vent hood often. Do not allow grease to build up on the hood or the filter.
41. Use care when cleaning the vent hood filter. Corrosive cleaning agents, such as lye-based oven cleaners, may damage the filter.
42. When flaming foods are under the hood, **turn the fan off.** The fan, if operating, may spread the flame.

**SAVE THESE INSTRUCTIONS**

# Installation Recommendations.....

Remove all packing materials both outside and inside the oven before using the oven. The oven requires free movement of air for proper operation. Do NOT block air vents located by the top air grill and underneath the oven.

## Grounding Instructions

This appliance **must** be grounded. In the event of an electrical short circuit, grounding reduces the risk of electric shock by providing an escape wire for the electric current. This appliance is equipped with a cord having a grounding wire with a grounding plug. The plug must be plugged into a 120v, 15amp. outlet that is properly installed and grounded.

**WARNING** – Improper use of the grounding plug can result in a risk of electric shock.

Consult a qualified ~~electrician~~ or service technician if the grounding instructions are not completely understood, or if doubt exists as to whether the appliance is properly grounded.

Where standard two-prong wall receptacle is encountered, it is your personal responsibility and obligation to have it replaced with a properly grounded three-prong wall receptacle.

Do not under any circumstances cut or remove the third (ground) prong from the power cord. Do not use an adapter plug with this appliance. See reference pages 1 and 2 of the Installation Guide for acceptable extension cord specifications.

## Interference Note

Microwave ovens generate radio frequency energy during operation, and if not installed properly may cause interference to radio and television reception. You can determine if this unit is causing interference by turning it on and off while the interference is occurring. If interference occurs, it may be corrected by one or more of the following measures:

- clean door and sealing surfaces of the oven;
- reorient the television or radio receiving antenna;
- relocate the oven with respect to the television or radio receiver, and/or
- plug the oven into a different outlet so that it and the television or radio receiver are on different circuits.

If the interference persists, you may want to consult an experienced radio/television technician for additional suggestions.

# Automatic Fan Protection Feature .....

Cooking appliances installed under the oven may, under some heavy usage conditions, cause temperatures high enough to overheat some internal parts of the microwave oven.

To prevent overheating from taking place, the exhaust fan is designed to automatically turn on at a low speed if excessive temperatures occur. Should this happen, the

fan cannot be manually turned off, but it will automatically turn off when the internal parts have cooled. The fan may stay on for up to an hour after the range and microwave oven controls have been turned off.

# Microwaving Tips.....

- Make sure all cookware used in your microwave oven is suitable for microwaving. Most glass cooking dishes, measuring cups, custard cups, pottery or china dinnerware, which does not have metallic trim or glaze with metallic sheen, can be used.
- If you are not sure if a dish is microwave-safe, use this test: Place in the oven the dish you are testing and a glass measuring cup filled with one cup of water. Set the measuring cup either in or next to the

dish. Microwave 1 minute at high. If the dish heats, it should not be used for microwaving. If the dish remains cool and only the water in the cup heats, then the dish is microwave-safe.

- Paper towels, waxed paper and plastic wrap can be used to cover dishes in order to retain moisture and prevent spattering. Be sure to vent plastic wrap so steam can escape.



# Touch Control Panel.....

The Touch Control Panel allows you to set the oven controls with the touch of a finger. It's designed to be easy to use and understand.

1. **DISPLAY** – Displays time of day, time or temperature during cooking functions, power level being used, cooking mode and instructions.
2. **POPCORN** - Touch this pad to cook prepackaged microwave popcorn weighing 1.75 or 3.5 ounces. The oven will start automatically. (Page 12)
3. **BEVERAGE** – Touch this pad to reheat a beverage. The oven will start automatically. (Page 13)
4. **FAVORITE CHOICE** - Touch this pad to recall three cooking instructions placed in memory and to program sound level of signals, scroll speed and disable clock display. (Page 13)
5. **BAKED POTATO** - Touch this pad to cook 1-4 potatoes. The oven will start automatically. (Page 13)
6. **DINNER PLATE** - Touch this pad to reheat a dinner plate full of chilled leftovers. (Page 13)
7. **FROZEN PIZZA** – Touch this pad to heat frozen pizza. The oven will start automatically. (Page 13)
8. **FROZEN VEGETABLE** - Touch this pad to cook frozen vegetables. The oven will start automatically. (Page 14)
9. **SENSOR COOK** - Will automatically compute the microwave power and cook time. Refer to Sensor Cook Guide. (Page 14)
  - ◆ Power Level 10 (High) is automatic but lower heat levels may be programmed. (Page 8)
10. **COOK TIME** – Microwave for a selected amount of time.
  - ◆ Power Level 10 (High) is automatic but lower heat levels may be programmed. (Page 8)
11. **AUTO DEFROST** – Touch this pad and enter food weight, then **START**. The oven automatically sets power levels and defrosting time. (Page 10)
12. **ADD MINUTE** - Touch this pad for 1 minute of cook time, to add 1 minute of cook time as the time is counting down or for an “instant on” for 1 minute. (Page 9)
13. **POWER** – Touch this pad if you want to change from automatic Power Level 10 (High) for cooking. (Page 8-9)
14. **NUMBER PADS** – Touch these pads to enter cooking time, defrosting time, time of day, power level or food weights for Auto Defrost.
15. **WARM** – Touch this pad and safely keep food warm for up to 30 minutes. (Page 14)
16. **TIMER** – This feature uses no microwave energy. It functions as either a kitchen timer, as a holding period after defrost or as a delay timer before cooking. (Page 9)
17. **TURNTABLE** – Touch this pad to turn the turntable on and off. (Page 16)
18. **CLOCK** – Touch this pad to enter time of day or check time of day while microwaving. (Page 8)
19. **CANCEL/OFF** - When touched once, it pauses the oven operation. When touched twice, it shuts off the oven and erases all settings (except time of day).
20. **START** – After all selections are made, touch this pad to start the oven or timer.
21. **VENT FAN** - Touch HI, LO, or OFF for the different fan speeds. (Page 17)
22. **LIGHT** – Touch ON to turn on the surface light. Touch NIGHT to turn on the night light. (Page 17)

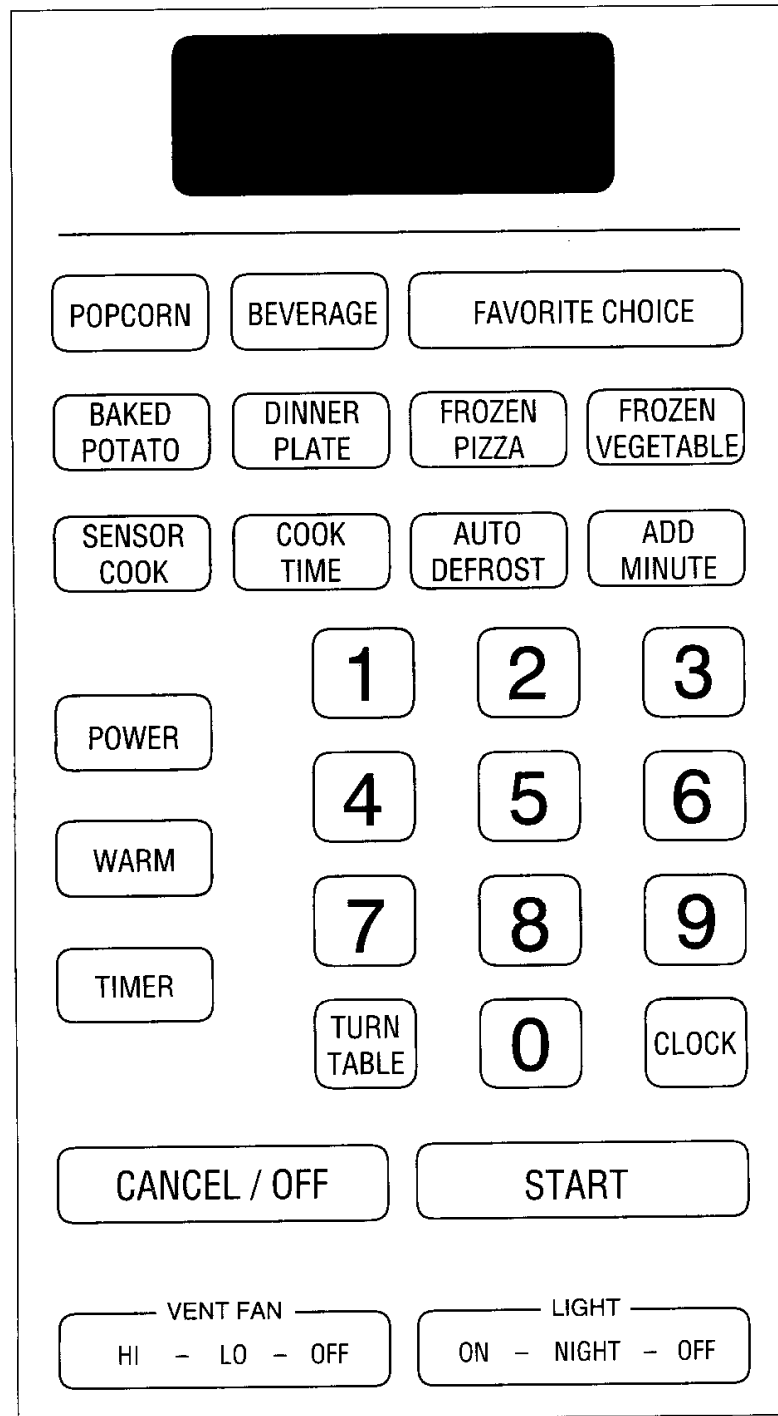

- Each time a pad is touched, a BEEP will sound.
- When **CANCEL/OFF** pad is touched during oven operation, the oven will stop, however, all programmed information is retained. To clear all information, touch the **CANCEL/OFF** pad again.
- NOTE: Styling and features may differ slightly depending on model.



# Oven Features at a Glance .....

## HOOD CONTROLS

**Vent Fan** - Press HI, LO or OFF  
**Light** - Press ON, NIGHT or OFF

## TOUCH CONTROL PANEL and DIGITAL DISPLAY

For detailed information on each feature, see Touch Control Panel section, page 5.

## RATING PLATE

Located on the inside wall of the microwave oven.

## DOOR LATCHES

## DOOR HANDLE

Pull to open door.  
Door must be securely latched for oven to operate.

## WINDOW with METAL SHIELD

Screen allows cooking to be viewed while keeping microwaves confined in oven.

## COOKTOP LIGHT

## GREASE FILTERS

## TURNTABLE

Composed of glass tray and roller guide. The roller guide is placed first in the bottom of the microwave and supports the glass tray. **Both parts must be in place when using the microwave oven.**

## OVEN SHELF

May be used when cooking more than one item at a time.

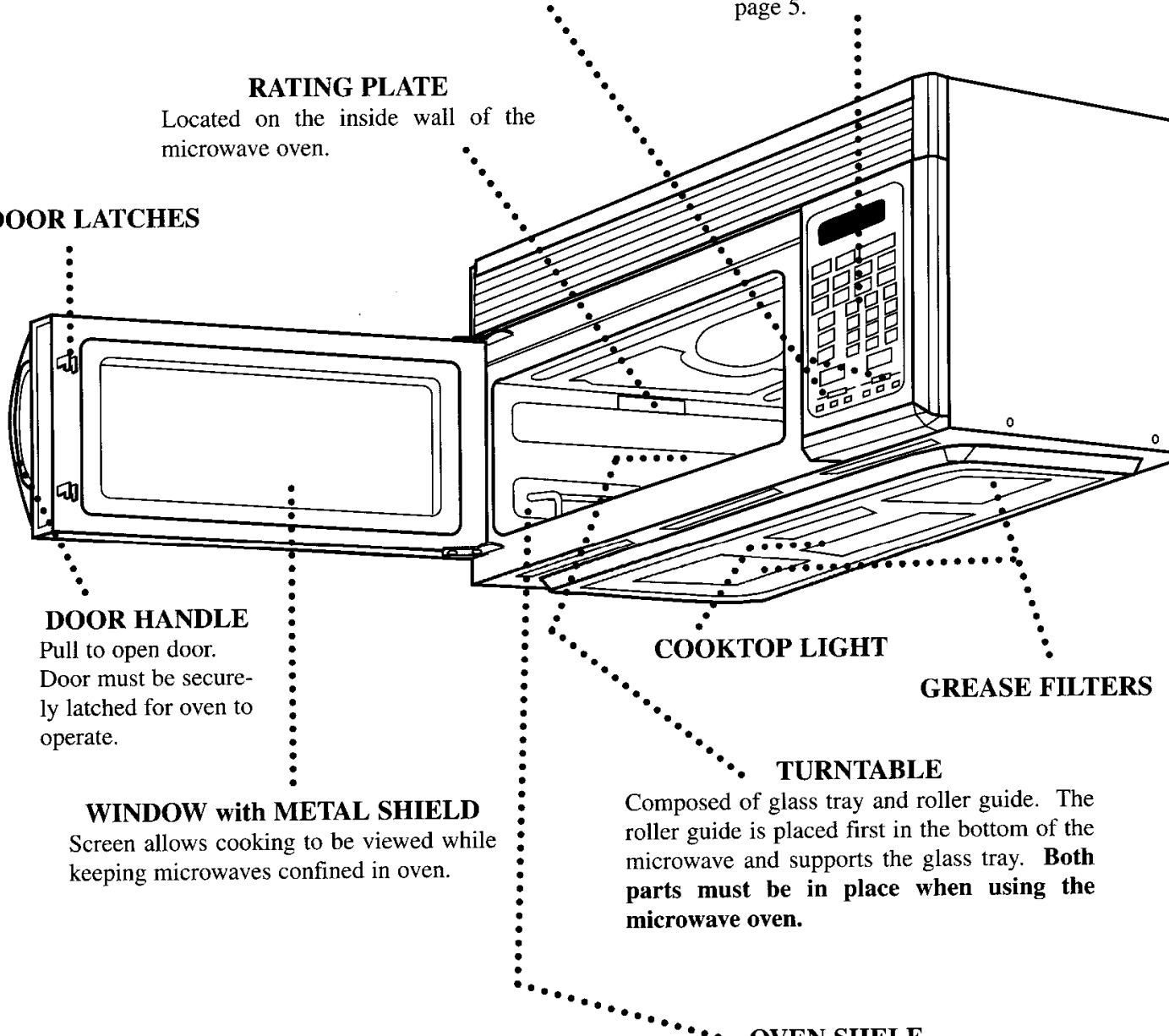





# Operating Basics .....

## ***Time-of-Day Clock***

### **Basic Instructions**

1. Touch the **CLOCK Pad**. "CLOCK--ENTER TIME" will be displayed.
2. Set the time of day by touching the appropriate numbers. The selected time appears and "PRESS CLOCK AGAIN" will be displayed.

3. Touch the **CLOCK Pad** again. The colon will flash.

- After plugging in the oven or after a power outage, the **Display** will scroll "TOUCH CLOCK PAD TO ENTER TIME OF DAY". Touch the **CANCEL/OFF Pad** and set the clock following the directions above.
- The "time-of-day" clock is a 12 hour clock.
- If set, the time of day will always be displayed when no other cooking function is being used.

---

## ***Cook Time/Power Level***

### **Basic Instructions**

1. Touch the **COOK TIME Pad**. "ENTER COOKING TIME" will be displayed.
2. Enter the cooking time by using the number pads. For example, for 5 minutes touch numbers 5, 0, 0. The selected time and "PRESS START" will be displayed.
3. Touch the **START Pad**. "COOK TIME" and selected time will be displayed.
  - The cooking time will appear in the **Display Window**.
  - The oven will start cooking and time countdown will begin.
  - The oven will stop automatically when the time is done and beep three times.

- When the cook time ends, "END COOK" appears in the **Display**.

- **Note:** Full power is automatic. If you wish to use a different power level, touch the **POWER Pad** before touching **START Pad**. "POWER LEVEL IS HI [10]. TOUCH 1-9 FOR NEW POWER LEVEL PRESS START" will be displayed. Enter the power level desired by touching the appropriate number pad. The selected power level and "PRESS START" will be displayed. (See **Cooking Guide on page 9**).
- Start with the shortest recommended time and add more time as needed.
- Check the food as it cooks.
- The oven door can be opened any time during operation. It will automatically stop and maintain the time setting until the door is closed and the **START Pad** is touched again.
- If the **START Pad** is touched and the oven does not operate, check the area between the door and door

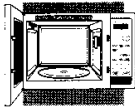

# Operating Basics .....

## Power Level Cooking Guide

The power levels on your microwave oven can be compared to the surface units on a range. HIGH (power level 10) or full power is the fastest way to cook and gives you 100% power.

Each power level gives you microwave energy for a certain percent of time, for example, power level 7 is microwave energy 70% of the time. Most of your cooking will be done on HIGH (Power Level 10). A lower setting will cook more evenly and with less attention given to stirring or rotating the food. Some foods may have better flavor, texture or appearance if one of the lower settings is used. You may wish to use a lower power level when cooking foods that have a tendency to boil over, such as scalloped potatoes. Cooking times will increase as the power level decreases.

Power Level	Best Uses
High 10	Fish, bacon, vegetables, boiling liquids
Medium 7	Gentle cooking of meat and poultry; baking casseroles and reheating
Medium 5	Slow cooking and tenderizing for stews and less tender cuts of meat.
Low 3	Defrosting; simmering; delicate sauces.
Warm 1	Keeping food warm without overcooking; softening butter

## Add Minute

The **ADD MINUTE Pad** provides a convenient way to heat foods at full power with one touch of a pad or add an extra minute to your cooking cycle when in progress. The microwave starts automatically after the pad is touched.

### Basic Instructions

1. Touch the **ADD MINUTE Pad**. The **Display** will show "PRESS AGAIN TO ADD MIN".

**ADD MINUTE** cannot be used with **ONE TOUCH COOKING FUNCTIONS, SENSOR COOK, AUTO DEFROST, TIMER, FAVORITE CHOICE** or **WARM**.

Each time the pad is touched the oven will add 1 minute to the time up to 99 minutes.

## Timer

### Basic Instructions

1. Touch the **TIMER Pad**. The **Display** will show "ENTER TIME".
2. Enter desired time. The **Display** will show the selected time and "PRESS START".
3. Touch the **START Pad**. The **Display** will show "TIMER" and selected time.

- The timer can be programmed up to 99 minutes and 99 seconds.
- Three beeps signal the end of the timing operation.
- To stop the timer once it has started, touch the **CANCEL/OFF Pad** twice. **Display** will return to the time of day or cooking program.
- The timer cannot be set while cooking.
- The door must be shut for the timer to operate.

## Auto Defrost

Use the defrost setting for defrosting meats, poultry and seafood from .5 pounds to 6.5 pounds.

### Basic Instructions

1. • Touch the **AUTO DEFROST Pad** once for meat. "MEAT DEFROST--ENTER FOOD WEIGHT IN LBS" will be displayed.
  - Touch the **AUTO DEFROST Pad** twice for poultry. "POULTRY DEFROST--ENTER FOOD WEIGHT IN LBS" will be displayed.
  - Touch the **AUTO DEFROST Pad** three times for fish. "FISH DEFROST--ENTER FOOD WEIGHT IN LBS" will be displayed.
2. Touch number pads to enter the weight.\* The defrosting time and power levels are automatically calculated.
3. Touch the **START Pad**. "DEFROST TIME" and time appear in the Display.

\* Enter the weight in pounds and tenths of a pound. See Conversion Chart below.

- During defrosting, the oven will beep a series of short beeps to signal that the food needs to be turned or rearranged. Oven will continue operating if food is not turned or rearranged. Three beeps signal the end of defrosting. "END" appears in the Display.

### Conversion Chart

If weight is in ounces -	then weight is converted to tenths-of-a-pound.
1 to 2-oz.	0.1
3 to 4-oz.	0.2
5-oz.	0.3
6 to 7-oz.	0.4
8-oz.	0.5
9 to 10-oz.	0.6
11 to 12-oz.	0.7
13-oz.	0.8
14 to 15-oz.	0.9

## Defrosting by Time

### Basic Instructions

1. Touch the **COOK TIME Pad**. "ENTER COOKING TIME" will be displayed.
2. Enter the defrosting time desired.
3. Touch the **POWER Pad**. "POWER LEVEL IS HI [10]" will be displayed.
4. Touch **NUMBER "3" Pad**. "PL-30 PRESS START" will be displayed.
5. Touch the **START Pad**.

- Three short beeps indicate an incorrect entry.
- See page 11 for additional defrosting tips for both Auto and Time Defrost.

See page 11 for additional defrosting tips for both Auto and Time Defrost.

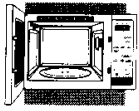

# Operating Basics.....

## Defrost by Time Guide (Power Level 3)

Items and Weight	Defrosting Time	Standing Time	Procedures and Techniques
<b>Beef</b>			
Ground Beef/1 lb.	10-12 min.	5 min.	Break apart and remove thawed portions with fork.
Ground Beef/2 lbs.	18-20 min.	8-12 min.	Break apart and remove thawed portions with fork.
Beef Roast, boneless/3 lbs.	26-28 min.	7-10 min.	Turn over part way. Shield ends or thinner areas with foil.
Steaks/1" thick	7-8 min.	5-7 min.	Separate and rearrange once.
<b>Pork</b>			
Pork Roast, boneless/3 lbs.	26-28 min.	10-15 min.	Turn over part way. Shield ends or thinner areas with foil.
Pork Chops/1 lb.	7-8 min.	5-7 min.	Separate and rearrange once.
Ground Pork/1 lb.	10-12 min.	5-7 min.	Break apart and remove thawed portions with fork.
Spareribs/12 lbs.	15-16 min.	5-7 min.	Turn meat over and rearrange, separate once.
<b>Poultry</b>			
Whole Chicken/3 lbs.	20-22 min.	10-15 min.	Turn chicken over. Shield wing tips, leg ends and breast areas with foil. Breast side down.
Chicken Breasts boneless/1 lb.	7-8 min.	5-7 min.	Separate and rearrange once.
Chicken Thighs/2 lbs.	18-23 min.	8-13 min.	Separate and rearrange once.
<b>Fish</b>			
Fish Fillets/1 lb.	10-11 min.	5-7 min.	Separate and rearrange once. Shield as needed.

### General Defrosting Tips

1. Do not defrost covered meat. Covering might allow cooking to take place. Always remove outer wrap and tray. Place food on a microwave-safe rack in a dish. During defrost, juices accumulate in dish and may become hot enough to cook the food. Elevating meat off of the dish will prevent the bottom and sides from beginning to cook.
2. Begin defrosting whole poultry breast-side-down. Begin defrosting roasts fat-side-down.
3. The shape of the package alters the defrosting time. Shallow rectangular shapes defrost more quickly than a deep block.
4. **Auto Defrost** is programmed for specific weights. Defrost results will be affected if you enter an incorrect weight.
5. **Auto Defrost** is programmed for frozen food at 0° F. If food is stored at a higher temperature, expect shorter defrost times.
6. After 1/3 of the defrost time has elapsed, check the food. You may wish to turn over, break apart, rearrange or remove thawed portions of the food.

7. **During Auto Defrost, the oven will prompt you to turn the food over.** At this point, open oven door and check the food. Follow the techniques listed below for optimum defrost results. Then, close oven door and touch **Start Pad** to complete defrosting.

- **Turn Over:** Roast, ribs, whole poultry, turkey breasts, hot dogs, sausages, steaks, or chops.
- **Rearrange:** Break apart or separate steaks, chops, hamburger patties, ground meat, chicken or seafood pieces, chunks of meat such as stew beef.
- **Shield:** Use small strips of aluminum foil to protect thin areas, edges of unevenly shaped foods such as chicken wings. To prevent arcing, do not allow foil to come within 1-inch of oven walls or door.
- **Remove:** To prevent cooking, thawed portions should be removed from the oven at this point. This may shorten defrost time for foods weighing less than 3-lbs.

8. After defrosting, allow food to stand 5 to 10 minutes if there are any icy areas. If large solid roasts, such as sirloin tip or rump roasts, are not completely thawed after standing, return roast to oven and program **Auto Defrost** for 1 lb.

## Two Stage Cooking

This feature lets you program two sequential operations such as defrosting and cooking or cooking using two dif-

ferent power levels. It automatically changes power settings and cooking time.

### Basic Instructions

1. Touch the **COOK TIME Pad**. "ENTER COOKING TIME" will be displayed.
2. Touch the appropriate number pads to enter the cooking time. The selected time and "PRESS START" will be displayed.
3. Touch the **POWER Pad**.\* "POWER LEVEL IS HI [10]. TOUCH 1-9 FOR NEW POWER LEVEL--PRESS START" will be displayed.
4. Touch the number pad for the power level you desire.\* The selected power level and "PRESS START" will be displayed.
5. Touch the **COOK TIME Pad** again. "ENTER SECOND COOKING TIME" will be displayed.
6. Touch the appropriate number pads to enter the cooking time for the second stage of cooking. The selected time and "PRESS START" will be displayed.
7. Touch the **POWER Pad**.\* "POWER LEVEL IS HI [10]. TOUCH 1-9 FOR NEW POWER LEVEL--PRESS START" will be displayed.
8. Touch the number pad for the power level you desire.\* The selected power level and "PRESS START" will be displayed.
9. Touch the **START Pad**.

- Three beeps signal the end of cooking. "END COOK" appears in the **Display**.
  - The audible beep between stages can serve as a reminder to add foods or ingredients.
- \* Skip steps 3 and 4 or 7 and 8 if full power is desired.



## Special Features.....

### Popcorn

#### Basic Instructions

1. Touch the **POPCORN Pad** once for 3.5 oz. package. The **Display** will show "3.50 OZ BAG OF POPCORN" or
2. Touch the **POPCORN Pad** twice for 1.75 oz. package. The **Display** will show "1.75 OZ BAG OF POPCORN".

- The **POPCORN Pad** has been automatically set for the correct cook time for a 3.5 oz. or 1.75 oz. bag of popcorn.
- Listen as the popcorn pops and stop the microwave when the popping slows down to 3 seconds apart.
- Do not try to repop unpopped kernels or reuse a bag.
- Pop only one package at a time.

**CAUTION:** If prepackaged popcorn is a different weight than the recommended weight, do not use the **POPCORN Pad**. Inadequate popping or a fire may occur. Follow manufacturer's instructions.

### Dinner Plate

#### Basic Instructions

1. Touch **DINNER PLATE Pad**. The **Display** will show "DINNER PLATE".

- The programmed time (3:00) will show in the **Display**.
- Place meat and dense vegetables to the outside of the plate.
- Place delicate foods in the center of the plate.
- Cover the plate with wax paper to hold steam around most foods except rare meats or vegetables with crisp exteriors.



# Special Features.....

## Frozen Pizza

### Basic Instructions

1. Touch the **FROZEN PIZZA Pad**. The Display will show "PIZZA".
- The programmed time (3:00) will show in the **Display**.
  - Time set is for 6.0 - 7.5 oz. pizzas.
  - Cook only one pizza at a time.
  - Follow manufacturer's directions.
  - Use only frozen pizza labeled microwaveable.
  - If cheese pizza does not melt sufficiently, cook a few seconds longer.

## Beverage

### Basic Instructions

1. Touch the **BEVERAGE Pad** once for 1 cup (7 oz.)/mug. The **Display** will show "1 CUP".
2. Touch the **BEVERAGE Pad** twice for 2 cups (14 oz.)/mugs. The **Display** will show "2 CUPS".
3. Touch the **BEVERAGE Pad** three times for 3 cups (21 oz.)/mugs. The **Display** will show "3 CUPS".

## Baked Potato

### Basic Instructions

1. Touch the **BAKED POTATO Pad**:
    - once for 1 medium potato (7 oz.)
    - twice for 2 medium potatoes (14 oz.)
    - three times for 3 medium potatoes (21 oz.)
    - four times for 4 medium potatoes (28 oz.)
- The **Display** will show "1 EA-POTATO", "2 EA-POTATO", "3 EA-POTATO" or "4 EA-POTATO".

## Favorite Choice

### To Program Favorite Choice Setting:

1. Touch the **COOK TIME Pad**. Set cooking time.
2. Touch the **POWER Pad**.
3. Enter power level. Example "5" for 50% power level.
4. Touch the **FAVORITE CHOICE Pad**.
5. Touch the **CANCEL/OFF Pad** to place in memory.

When program has been entered, "MEMO" will appear in the **Display** to let you know that the program has been entered.

### To Change Favorite Choice Setting:

- Touch and hold **FAVORITE CHOICE Pad** for 3 seconds. **Display** shows "PROG 1". Previously set information will be erased.
- Follow previous steps 1-5 to program new settings.

### To use Favorite Choice:

1. Put food in oven and close door.
2. Touch **FAVORITE CHOICE Pad**. "PROG 1" will appear in the display.
  - To select program 2 or 3 press **FAVORITE CHOICE Pad** until desired program number appears in the display.
3. Touch the **START Pad**.

### To Program Favorite Choice Signal Sound, Scroll Speed and Clock Display:

Touch **FAVORITE CHOICE Pad** four times "PROG 4 SELECT TYPE ENTER 1-5" will be displayed.

### To Change Signal Sound:

- Touch number pad 1. "BUZZER ON" will be displayed.
- Touch number pad 2. "BUZZER OFF" and "MUTE" will be displayed. "MUTE" will remain in the **Display** until the buzzer is turned on. Touch **STOP/CLEAR Pad**.

### To Change Scroll Speed:

- Touch number pad 3. "HIGH SCROLL SPEED" will be displayed. Touch **STOP/CLEAR Pad**.
- Touch number pad 4. "NORMAL SCROLL SPEED" will be displayed. Touch **STOP/CLEAR Pad**.

### To Turn Clock Display On/Off:

- Touch number pad 5. Signal will sound and the **Display** will go blank. To recall the time of day, touch the **START Pad** and the current time of day will be displayed for 10 seconds.

## Warm

### Basic Instructions

1. Touch the **WARM Pad**. The display will show "WARM-PRESS START".
2. Touch the **START Pad**.
  - The microwave oven will safely keep cooked foods warm for up to 30 minutes.
  - Opening the door or touching the **CANCEL/OFF Pad** cancels the WARM setting.
  - Foods that were covered during cooking should be covered during warming.
  - Complete meals on a dinner plate should be covered.

## Frozen Vegetable

### Basic Instructions

1. Touch the **FROZEN VEGETABLE Pad** once for 8 oz. frozen vegetable. The **Display** will show "8 OZ--FRZ-VEG".
2. Touch the **FROZEN VEGETABLE Pad** twice for 10 oz. frozen vegetable. The **Display** will show "10 OZ--FRZ-VEG".
3. Touch the **FROZEN VEGETABLE Pad** three times for 16 oz. frozen vegetable. The **Display** will show "16 OZ--FRZ-VEG".
4. Touch the **FROZEN VEGETABLE Pad** four times for 20 oz. frozen vegetable. The **Display** will show "20 OZ--FRZ-VEG".

## Sensor Cook

**SENSOR COOK** will automatically customize the cook time for food in four categories - soup, fresh vegetables, muffins, and fish fillets.

### Basic Instructions

1. Touch the **SENSOR COOK Pad** until the desired food is displayed.\*
2. Touch the **START Pad**.

## Sensor Cook Guide

FOOD	TOUCH SENSOR COOK PAD	DISPLAY GUIDE	QUANTITY
Soup	Once	"SOUP--PRESS START"	8-32 oz.
Fresh Vegetables	Twice	"FRS VEG--PRESS START"	4-16 oz.
Muffins	Three Times	"MUFFIN--PRESS START"	2-8 ea.
Fish Fillets	Four Times	"FISH--PRESS START"	4-16 oz.

## Cooking Tips and Techniques

- For best results, cover container with plastic wrap and turn back one edge of the wrap to form a 1/2-inch slot where steam can escape.
- After cooking fresh vegetables, allow 3-5 minutes of stand time before serving. This will allow the food to finish cooking without overcooking.
- When preparing fresh vegetables, add 1/2 cup of water per 1/2 pound of fresh vegetables.



# Special Features.....

## Auto Start

The **AUTO START** feature allows you to program your oven to begin cooking at a preset time of day – up to a delay of 11 hours and 59 minutes. You can program two sequential operations using two different power levels.

### Basic Instructions

1. Touch **COOK TIME Pad**.
2. Enter the cooking time.\*
3. Touch the **POWER Pad**.
4. Enter the power level.
5. Touch **COOK TIME Pad**.
6. Enter cooking time.
7. Touch the **POWER Pad**.
8. Enter the power level.
9. Touch the **CLOCK Pad**.
10. Enter the clock time you want the oven to start.
11. Touch the **START Pad**\*\*.

\* If you wish to cook with one Stage, omit steps 5, 6, 7 & 8.

\*\* The oven will start cooking at the set time. If the door is opened before the start time is reached, touch the **START Pad** to resume the **Auto Start** option.

- The **AUTO START** feature cannot be used with the following options: **POPCORN, FROZEN PIZZA, BEVERAGE, FROZEN VEGETABLE, DINNER PLATE, BAKED POTATO, WARM, ADD MINUTE, TIMER, FAVORITE CHOICE, AUTO DEFROST** and **SENSOR COOK**.
- Do not use foods containing baking powder or yeast when using **AUTO START**. They will not rise properly.
- **Warning:** Do not use foods that will spoil while waiting for cooking to start, such as dishes with milk or eggs, cream soups and cooked meats or fish. Any food that has to wait for cooking to start should be very cold or frozen before it is put in the oven. Unfrozen foods should never stand more than two hours before cooking starts.

Do not allow food to remain in the oven for more than two hours after end of cooking cycle.

### To Check Auto Start Time

Touch the **CLOCK Pad**. The programmed **AUTO START** time and “**AUTO START COOKING TIME---**” will appear in the **Display**.

### Tips on Setting Auto Start

- Before setting, check that the correct time of day is displayed.
- If you hear the fan start when you touch the **START Pad**, you have not set the oven properly. Touch the **CANCEL/OFF Pad** and start over.

## More or Less Time Adjustment

You may increase or decrease any of the pre-set settings for the **ONE TOUCH COOKING FEATURES** if you prefer more or less cooking time.

### To Adjust the Pre-set Settings:

1. Touch the **POWER Pad** once to decrease the time by 20 seconds or twice to increase the time by 20 seconds.
2. Touch the desired **ONE TOUCH COOKING Pad**.



---

## Control Lockout

The oven operation can be locked to prevent the microwave from accidentally being turned on. All oven functions can be locked.

### To Set:

Touch and hold the **CANCEL/OFF PAD** for three seconds. The **Display** shows "LOCKED" and the oven beeps.

### To Cancel:

Touch and hold the **CANCEL/OFF PAD** for three seconds. "LOCKED" disappears from the **Display** and the oven beeps.

## Turntable On/Off

For best cooking results, leave the turntable on. When using larger dishes, it can be turned off.

- Press **TURNTABLE Pad** to turn the turntable on or off.
- Display will show the T/T OFF indicator light.

## Oven Shelf

The oven shelf gives you extra space when cooking in more than one container at the same time. (See illustrations below.)

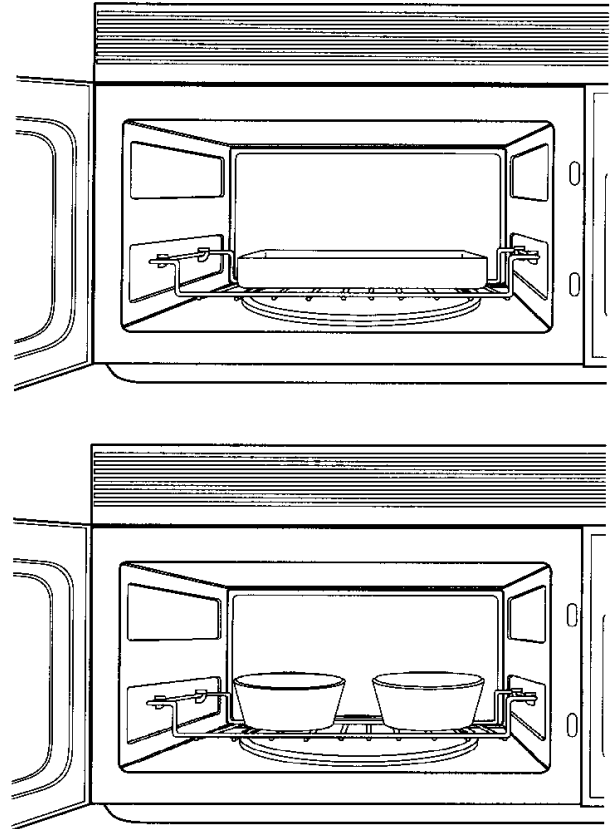

- Do not cook with the shelf on the microwave floor. This could damage the microwave.
- Do not use a microwave browning dish on the shelf. The shelf could overheat.
- Use a potholder when handling the shelf after cooking. It may be hot.
- Do **not** use the shelf when popping popcorn.

# Special Features .....

## *Using the Vent Fan*

The three pads on the bottom left of the control panel control the 2-speed **FAN**.

1. Choose fan speed.
  - Touch **HI Pad** or **LO Pad**. The **Display** will scroll "FAN ON HIGH" or "FAN ON LOW".
2. Turn off fan when desired.
  - Touch **OFF Pad**

**NOTE:** If the temperature gets too hot around the microwave oven, the exhaust fan in the vent hood will automatically turn on the **LO** setting to protect it. It may stay on up to an hour to cool the microwave oven. When this occurs, the **FAN OFF** pad will not turn the fan off.

### ***To set fan to run for a specific time:***

1. Start fan by touching **HI Pad** or **LO Pad**.
2. Program run time.
  - Touch the **TIMER Pad** and hold for 3 seconds. **Display** will show "FAN".

**NOTE:** If both the fan and light are operating and the **TIMER Pad** is touched and held, both the fan and light will be controlled by the timer. The display will alternate between "FAN" and "LIGHT" one time.

3. Enter desired time.
4. Touch the **START Pad**.

### ***To cancel timer:***

- Touch **CANCEL/OFF pad** twice.

**NOTE:** Canceling the timer will cause the timer to shut off; however, canceling the timer will not cancel the fan. The fan will continue to operate until turned off.

## *Using the Cooktop Light*

The three pads on the bottom right of the control panel control the cooktop light.

1. Choose light.
  - Touch **ON Pad** or **NIGHT Pad**. The **Display** will scroll "LIGHT ON" or "NIGHT LIGHT".
2. Turn off light when desired.
  - Touch **OFF Pad**.

### ***To set light to be on for a specific time:***

1. Turn on light by touching **ON Pad** or **NIGHT Pad**.
2. Program "ON" time.
  - Touch the **TIMER Pad** and hold for 3 seconds. **Display** will show "LIGHT".

**NOTE:** If both the fan and light are operating and the **TIMER Pad** is touched and held, both the fan and light will be controlled by the timer. The display will alternate between "FAN" and "LIGHT" one time.

3. Enter desired time.
4. Touch the **START Pad**.

### ***To cancel timer:***

- Touch **CANCEL/OFF Pad** twice.

**NOTE:** Canceling the timer will cause the timer to shut off; however, canceling the timer will not cancel the light. The light will continue to operate until turned off.



# Care and Cleaning.....

## **Microwave Oven Interior**

The oven interior should be cleaned after each use with a damp cloth to keep it free from grease and soil buildup. Stubborn soils can be removed with a plastic scrub pad. When cleaning interior surfaces and surfaces of door and oven that come together when the door is closed, use only mild, non-abrasive soaps or detergents applied with a sponge or soft cloth.

Odors can be eliminated from the inside of the oven by boiling a solution of one cup of water and several tablespoons of lemon juice in the oven for 5-7 minutes. This also helps loosen any dried soil in the oven. Wipe off excess moisture after use.

**Do not** spray or pour liquid cleansers directly onto a surface. Spray or pour cleanser onto a cloth or sponge and then clean.

**Do not** use abrasive cleaners, oven cleaners, abrasive cleaning pads or steel wool, as they can scratch or dull oven surfaces.

**Do not** remove or insert knife around the stirrer cover to clean, it may damage the cover or affect the cooking performance of your oven.

## **Oven Bottom**

Wash oven bottom with hot sudsy water, rinse and dry. Do not use excessive amounts of water when cleaning the oven, especially around the turntable. Do not allow water or cleaning agents to seep into turntable gears located underneath.

## **Glass Tray/Turntable**

Allow to cool before removing and cleaning. Wash in soapy water or dishwasher.

## **Roller Guide**

Clean frequently to prevent excessive noise. Wash in soapy water or dishwasher.

## **Oven Exterior**

Wipe the outside of your oven with a soapy cloth, rinse and dry.

**Stainless Steel/Brushed Chrome** (select models):

- **DO NOT USE ANY CLEANING PRODUCT CONTAINING CHLORINE BLEACH.**
- **ALWAYS WIPE WITH THE GRAIN WHEN CLEANING.**
- **TO PREVENT SCRATCHING, DO NOT USE ABRASIVE OR CAUSTIC AGENTS.**
- **Daily Cleaning/Light Soil** -- Wipe with one of the following - soapy water, white vinegar/water solution, Formula 409 Glass and Surface Cleaner\* or a similar multi-surface cleaner - using a sponge or soft cloth. Rinse and dry. To polish and help prevent fingerprints, follow with Stainless Steel Magic Spray (Part No. 20000008).\*\*
- **Moderate/Heavy Soil** -- Wipe with one of the following - Bon Ami or Soft Scrub\* - using a damp sponge or soft cloth. Rinse and dry. To restore luster and remove streaks, follow with Stainless Steel Magic Spray (Part No. 20000008).\*\*
- **Discoloration** -- Using a damp sponge or soft cloth, wipe with Cameo Stainless Steel Cleaner\*. Rinse immediately and dry. To polish and help prevent fingerprints, follow with Stainless Steel Magic Spray (Part No. 20000008).\*\*

## **Light Compartment**

Clean off the grease and dust on the light compartment cover on the bottom side of the microwave oven often with warm water and detergent.

## **Control Panel**

Wipe with a damp cloth. Dry. Do not spray cleansers directly on panel. Spray cleansers on cloth and then wipe.

\* Brand names are trademarks of the respective manufacturers.

\*\* To order call 1-800-688-8408.



# Care and Cleaning.....

## ***The Exhaust Feature***

The exhaust hood feature on your microwave oven is equipped with two metal filters which collect grease. When the fan is operating, air is drawn up through the filters and is then discharged through the venting to the outside or through the charcoal filters if not vented to the outside.

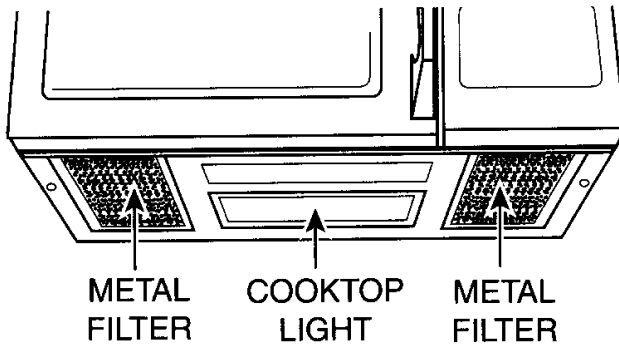

## ***Reusable Grease Filters***

The reusable grease filters should be cleaned at least once a month. Never operate the microwave without the filters in place. In situations where flaming might occur on surfaces below the hood, filters will stop the entry of flames into the unit.

## ***To Remove Grease Filter***

To remove grease filter, grasp the "finger hold" on the filter and slide to the rear. Then pull filter downward and to the front. The filter will drop out.

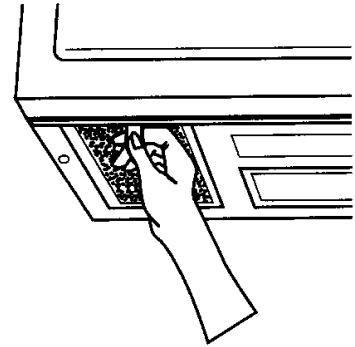

## ***To Clean Grease Filter***

To clean grease filters, soak and then agitate filter in solution of hot water and detergent. Do not use ammonia or ammonia products because they will darken the metal. Light brushing can be used to remove embedded dirt. Rinse, shake and remove moisture before replacing.

## ***To Replace Grease Filter***

To replace grease filter, slide the filter in the frame slot on the back of the opening. Pull filter upward and to the front to lock into place.

.....

## Light Bulb Replacement

### Cooktop Light

To replace the combination cooktop light/night light:

1. Disconnect power at main fuse or circuit breaker or pull plug.
2. Remove screw on left side of light compartment cover and lower cover until it stops. (See Figures 1 and 2.)
3. Gently unscrew the bulbs. Be sure bulbs to be replaced are cool before removing.
4. Replace with 30-watt incandescent bulbs available from your authorized dealer. High intensity 30-watt bulbs which are available in supermarkets and hardware stores, may also be used for replacements.
5. Raise light compartment cover and replace screw.
6. Connect electrical power to microwave oven.

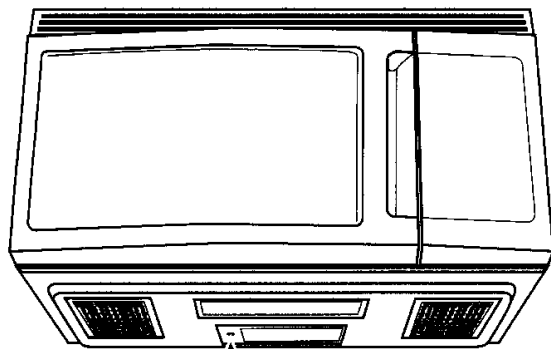

FIGURE 1

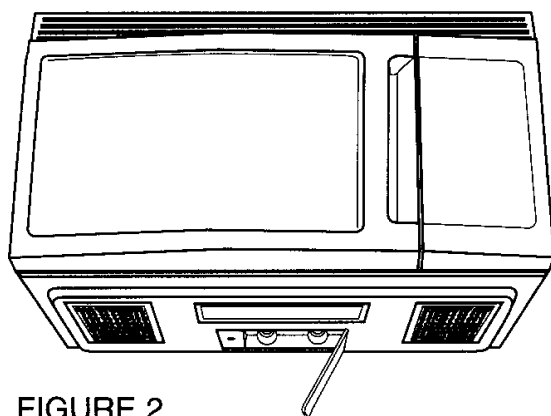

FIGURE 2

### Oven Light

To replace your oven light:

1. Disconnect power at main fuse or circuit breaker or pull plug.
2. Remove the top grill by taking out the 2 screws that hold it in place. (See Figure 3.)
3. Remove charcoal filter.
4. Remove oven light lens cover screw. (See Figure 4.)
5. Replace the light bulb with 30-watt bulb.
6. Rotate light housing to original position.
7. Reinstall light lens cover screw.
8. Reinstall charcoal filter.
9. Replace top grill and secure with screws.
10. Connect electrical power.

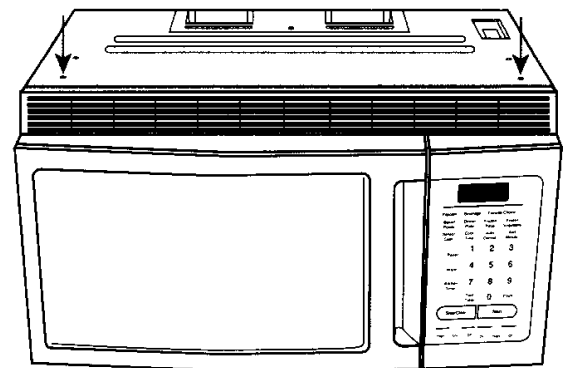

FIGURE 3

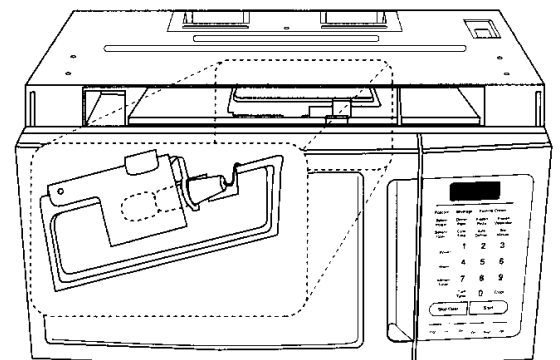

FIGURE 4



## Questions and Answers.....

**Q. Can I open the door when the oven is operating?**

**A.** The door can be opened anytime during the cooking operation. The oven will automatically stop cooking and the time setting will maintain until the door is closed and the **START Pad** is touched.

**Q. What causes the oven interior light and display to dim when using a Variable Power Level?**

**A.** This is normal and indicates the oven is operating and cycling properly.

**Q. Why does steam and/or vapor escape around the door and moisture droplets form on the inside of the oven door?**

**A.** This is normal occurrence – as food cooks, steam is given off.

***All these things are normal with your microwave oven.***

- Steam or vapor escaping from around the door.
- Light reflection around the door or outer case.
- Dimming oven light and change in blower sound may occur while operating at power levels other than high.
- Dull thumping sound while oven is operating.

**Q. What do the various beeps mean?**

**A.** Short beep = any pad is touched.

Three short beeps = incorrect entry.

One long beep = oven plugged in.

Three long beeps = end of cooking (microwave will turn off).

Series of three short beeps = check food to see if turning or rearranging is needed.

**Q. Can the oven be used with the glass tray or roller guide removed?**

**A.** No. Both the glass tray and roller guide must always be used in the oven when cooking.

### ***Charcoal Filter Kit***

There is a recirculating charcoal filter kit included for the microwave oven if it is not vented to the outside. See installation guide for details.



# Before You Call.....

**Check the following to be sure a service call is necessary.**

## ***If nothing on the oven operates:***

- check for a blown circuit fuse or a tripped main circuit breaker.
- check if oven is properly connected to electric circuit in house.
- check that controls are set properly.
- check that the cooking time is set.

## ***If the oven interior light does not work:***

- the light bulb may be loose or defective. Check the light by following directions on page 20 or call a qualified servicer.

## ***If oven will not cook:***

- check that control panel was programmed correctly.
- check that door is firmly closed.
- check that **START Pad** was touched.
- **Auto Start** may have been set.
- the **Control Lockout** may have been set.
- check the area between the door and seal for obstructions.

## ***If oven takes longer than normal to cook or cooks too rapidly:***

- be sure the **Power Level** is programmed properly.
- check instructions on food density, etc.
- verify that voltage to the microwave oven is not low.

## ***If the time-of-day clock does not always keep correct time:***

- check that the power cord is fully inserted into the outlet receptacle.
- check that the oven is properly grounded.
- try plugging the oven into an outlet on a separate electrical circuit.

## ***If oven floor or glass tray are hot:***

- this is normal. The floor is absorbing heat from the food.

## ***If the interior of oven collects moisture:***

- this is normal. Food gives off moisture when cooking and the steam collects on the door and the oven surface. Wipe off excess moisture from oven after each use.

## ***If food cooks unevenly:***

- refer to your recipe for proper cooking procedures.
- be sure food is evenly shaped.
- be sure food is completely defrosted before cooking.
- check placement of aluminum strips used to prevent overcooking.

## ***If food is undercooked:***

- check recipe to be sure all directions (amount, time, and power levels) were correctly followed.
- check household voltage.
- try plugging the oven into an outlet on a separate electrical circuit.
- be sure food was completely defrosted before cooking.

## ***If food is overcooked:***

- check recipe to be sure all directions (amount, time, and power levels) were correctly followed.
- the initial temperature of food may have been higher than normal.

## ***If arcing (sparks) occur:***

- be sure microwave-safe dishes were used.
- be sure wire twist ties were not used.
- be sure oven was not operated when empty.

## ***If the display shows a time counting down but the oven is not cooking:***

- check that door is firmly closed.

*For further assistance contact your Maytag Dealer or call Maytag Customer Service:  
U.S. 1-800-688-9900 or Canada 1-800-688-2002*



# Microwave Oven Warranty .....

## Full Two Year Warranty

For two (2) years from the date of original retail purchase, any part which fails in normal home use will be repaired or replaced free of charge.

## Limited Warranty

After the second year from the date of original retail purchase, through the fifth year, the following parts which fail in normal home use will be repaired or replaced free of charge for the part itself, with the owner paying all other costs, including labor, when the appliance is located in the United States or Canada: (1) Touch pad and microprocessor (2) Magnetron tube (3) High voltage transformer (4) High voltage capacitor (5) High voltage rectifier.

## Limited Parts Warranty (Outside the United States or Canada)

For one (1) year from the date of original retail purchase, any part which fails in normal home use will be repaired or replaced free of charge for the part itself, with the owner paying all other costs, including labor, when the appliance is located outside the United States or Canada.

## Canadian Residents

This warranty covers only those appliances installed in Canada that have been listed with Canadian Standards Association unless the appliances are brought into Canada due to transfer of residence from the United States to Canada.

## What is Not Covered by These Warranties

1. Conditions and damages resulting from any of the following:
    - a. Improper installation, delivery or maintenance.
    - b. Any repair, modification, alteration, or adjustment not authorized by the manufacturer or an authorized servicer.
    - c. Misuse, abuse, accidents or unreasonable use.
    - d. Incorrect electric current, voltage or supply.
    - e. Improper setting of any control.
  2. Warranties are void if the original serial numbers have been removed, altered, or cannot be readily determined.
  3. Light bulbs.
  4. Products purchased for commercial or industrial use.
  5. The cost of service or service call to:
    - a. Correct installation errors.
    - b. Instruct the user on the proper use of the product.
    - c. Transport the appliance to the servicer.
  6. Consequential or incidental damages sustained by any person as a result of any breach of these warranties.
- Some states do not allow the exclusion or limitation of consequential or incidental damages, so the above exclusion may not apply.

## If You Need Service

- Call the dealer from whom your appliance was purchased or call Maytag Appliances Sales Company, Maytag Customer Assistance at 1-800-688-9900, USA; or 1-800-688-2002, Canada to locate an authorized servicer.
  - Be sure to retain proof of purchase to verify warranty status. Refer to WARRANTY (above) for further information on owner's responsibilities for warranty service.
  - If the dealer or service company cannot resolve the problem, write to Maytag Appliances Sales Company, Attn: CAIR® Center, P.O. Box 2370, Cleveland, TN 37320-2370, or call **1-800-688-9900 USA, 1-800-688-2002 CANADA or 1-423-472-3333.**
- U.S. customers using TTY for deaf, hearing impaired or speech impaired, call 1-800-688-2080.
- NOTE:** When writing or calling about a service problem, please include the following information:
- a. Your name, address and telephone number;
  - b. Model number and serial number;
  - c. Name and address of your dealer or servicer;
  - d. A clear description of the problem you are having;
  - e. Proof of purchase (sales receipt).
- User's guides, service and parts information are available from Maytag Appliances Sales Company, Maytag Customer Assistance.

MAYTAG • 403 W. 4th St. N. • Newton, Iowa 50208

**MAYTAG ONLINE** <http://www.maytag.com>